

BE-D Series

User Manual

CE

INDEX

INTRODUCTION	2
PRODUCT DESCRIPTION AND PRODUCT CODES	2
DISCLAIMER AND PURPOSE OF THIS MANUAL	3
ACCESS CONTROL AND IDENTIFICATION MODES	3
HMI	6
CHARGING PROCESS	8
CONNECTIVITY	14
PRODUCT SPECIFICATIONS, STANDARDS and REGULATIONS	15
MAINTENANCE	17
WARRANTY	17
DISPOSAL INSTRUCTIONS	17

INTRODUCTION

Scame BE-D wallbox is a wall-mounted DC charger designed for Battery Electric Vehicles (BEVs) and Plugin Hybrid Electric Vehicles (PHEVs). It is compatible with either CCS type 2, or CHAdeMO, or both charging methods depending on the configuration of choice.

The wallbox features a HMI that consists of a 7" TFT touch display, a motion and ambient light sensor, as well as an RFID card reader. These features enable a seamless and intuitive charging experience.

The unit meets IP54 and IK10 ratings and, therefore, it is suitable to be installed both indoors and outdoors. It can be used in private, semi-public, as well as public areas, depending on the identification strategies enabled at the time of commissioning.

PRODUCT DESCRIPTION AND PRODUCT CODES

- Part Numbers 206.D91-E10 support CCS type 2 charging method only.
- Part Numbers 206.D91-E11 support CHAdeMO charging method only.
- Part Numbers 206.D91-E12 support both CCS type 2 and CHAdeMO charging methods nonsimultaneously.

Each configuration envisages a wireless router and an electrical cabinet with either one or two cordsets tethered to it. Dedicated connector holders are also available to guarantee IP54 ingress protection rating and neatly store either cordset while not being used for charging.

PART NUMBER	CCS TYPE 2	CHAdeMO
206.D91-E10	•	
206.D91-E11		•
206.D91-E12	•	•

PART NUMBER	Description
208.AP62	CCS type 2 IP54 IK10 connector holder
208.AP63	CHAdeMO IP54 IK10 connector holder
208.AP64	Filter Cloths KIT

DISCLAIMER AND PURPOSE OF THIS MANUAL

BE-D wallbox should be installed, operated, serviced, and maintained only by qualified personnel. No responsibility is assumed by SCAME PARRE S.p.A. for any consequences caused by improper use of this material. The technical documentation is an integral part of this product. Always keep it at hand until the unit reaches its end of life, as it provides important information. It should also be shared with all the people concerned if you sell, assign or lend the product to others. This guide must be read in integrality along with others related documents. It is prohibited to use extension cords to connect the vehicle. Adaptors or conversion adaptors are not allowed to be used either.

ACCESS CONTROL AND IDENTIFICATION MODES

Starting a charging session on BE-D wallbox can be done by selecting different access profiles, depending on the installation site and use cases of interest.

Access profile configuration must be done via Scame's local management system.

To access the management system one shall connect to the station network and enter their credentials. No software installation is required.

IP address(DEFAULT): 192.168.30.126

Username: administrator

Password: Admin123-

FREE ACCESS MODE

In access controlled locations, such as gated and fenced areas, the unit is typically setup in free mode, i.e. anybody able to physically access the charger is authorized to use it by default. In other words, no explicit user identification is needed in order to e.g. start or stop charging sessions. The built-in RFID card reader is therefore disabled.

BE-D SERIES

The selected operating mode of the charging station is displayed on the management system interface under the “Connectors” section in the menu.



Image 1

Authentication access mode

Access to a charging session can be limited to authorized users.

This operating mode is suitable for installation in all places and in all cases where access to the charging stations needs to be regulated.

Authorizations can be managed in two possible ways:

- Locally via Scame Management System (Net Local)
- Remotely via an OCPP Central Station (Net OCPP)

Authorization via user cards (Net Local)

In this case the RFID card reader is enabled and the unit is setup in such a way as to grant permission to charge only to users holding previously authorized RFID cards.

The registration of authorized user cards is done directly at the charger level via the Scame Management System.

To configure this Mode click on the “change mode” interface button.



Image 2

And then confirm passage to “Net”

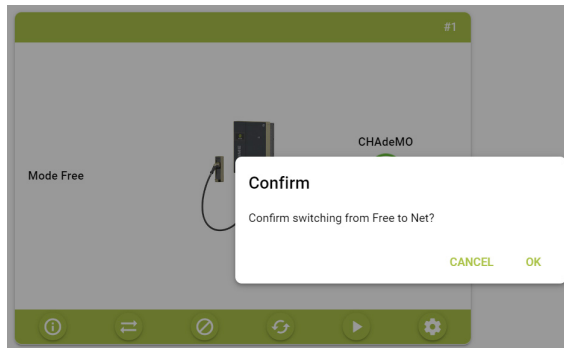

Image 3

Once the station has been set to work in “NET” mode, the administrator can then add new user cards. To add new cards select “Cards” in the menu and click on “Add Card” button on the interface.

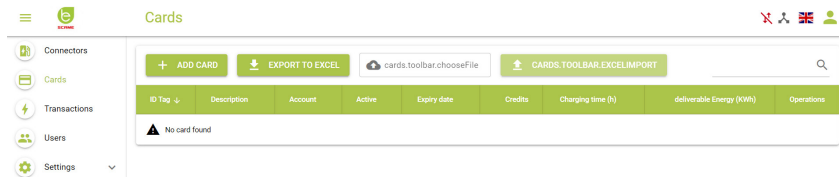

Image 4

Authorization via OCPP central station (Net OCPP)

It is possible to configure the station so that it is monitored and controlled by a central station via OCPP 1.6 JSON protocol.

In this situation all the use cases typically featured by charging platforms, such as billing, charger reservations and remote identification via a mobile app are supported.

Note that registration of authorized users must be done via the central station platform and in most cases third party E-mobility Service Providers will supply their own stack of user cards or provide information on how to perform new users registration (e.g. via mobile app, guest account and so on).

Connecting the stations to a third party central station may require you to sign a contract with the E-mobility Service Provider and yearly subscription fees may apply.

In order to configure the station to work via OCPP Central Station, with the station set in “Net mode”,

BE-D SERIES

enter into “Settings” in the menu and then select “Operating mode”.

Once selected, in the interface change Settings.logic.systemLogic from “Local” to “OCPP1.6 JSON” and fill in the required configuration parameters (these parameters must be supplied by the EMSP).

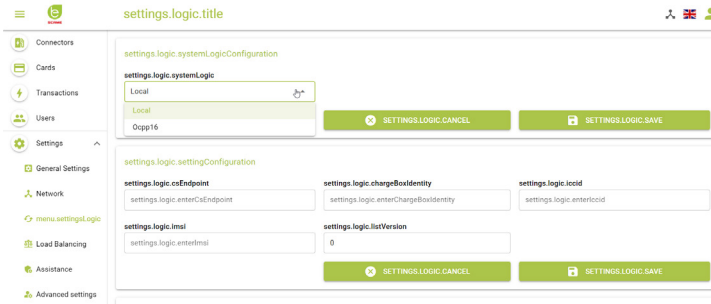

Image 5

HMI

BE-D wallbox features a 7”TFT touch display which intuitively guides the end user through all the necessary identification and connection steps. For a both user friendly and environmentally friendly experience the display backlight is dynamically adjusted according to the data sensed by the motion and ambient light sensor, as it will be explained in the following. Image 6 depicts the TFT touch display. The motion and ambient light sensor is embedded in the TFT frame. Its two circular openings are visible at the center of the bottom side.

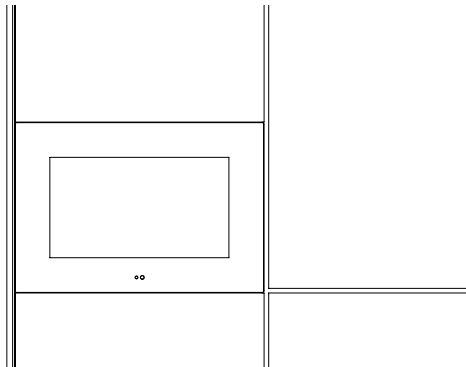

Image 6: HMI detailed view

While the charger is not being used, the display backlight is dimmed in discrete steps based on the ambient brightness. For example, at night the dimming will be more pronounced, while on a bright day with sunlight shining directly at the display the dimming will be much less pronounced. The system is therefore designed in

such a way as to clearly show that the charging infrastructure is up and running, without unnecessarily shining excessive light at the user's eyes. This strategy maximizes the display lifespan while saving electric energy.

At a distance of approximately half a meter the motion sensor detects that an end user is approaching. This causes the charger to exit its default non-operational state and enter the operational mode. This is made evident to the end user by immediately increasing the display brightness, which level is still being adjusted in discrete steps depending on the ambient light. Alternatively, the operational mode can be entered by directly tapping on the touch display.

In operational mode the end user is stepped through the charging process as it will be explained in detail in the following chapter.

If applicable, depending on the identification method of choice, the user simply needs to present a previously activated RFID card in front of the built-in RFID reader. This is located on the right hand side of the display and, as shown by image 7, is marked by the RFID designating symbol.

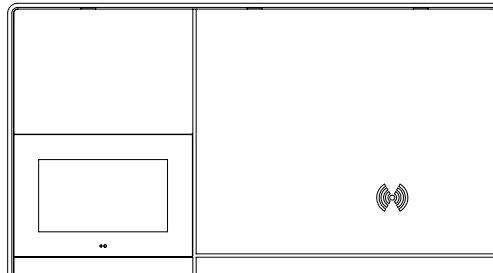

Image 7: RFID reader

BE-D SERIES

CHARGING PROCESS

While being in the default non-operational state BE-D wallbox shows the “be logo” on the TFT display.



Image 8: be logo screensaver

By either triggering the motion sensor or by tapping on the TFT display the charger enters the operational mode and the display shows the connectors selection screen. If the unit operates in FREE mode, no identification is needed to start the charge. The RFID card needs to be presented in front of the rfid reader otherwise. This can have either one or two connectors depending on the specific model of the unit: 206.D91-E10 shows CCS type 2 only, 206.D91-E11 shows CHAdeMO only, and 206.D91-E12 shows both – see image 9.

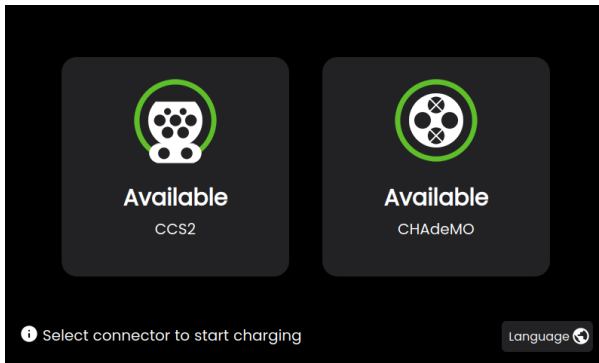

Image 9: 206.D91-E12 with both connector

Depending on what charging methods the electric vehicle that needs charging supports, the selection is made by tapping on the corresponding connector symbol.

If needed, the language can also be changed at this time by tapping on the world map in the corner. Image 11

shows the language selection screen, among with the supported languages.

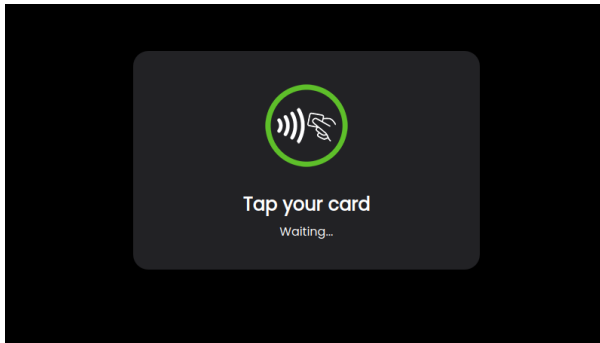

Image 10: RFID reader display screen

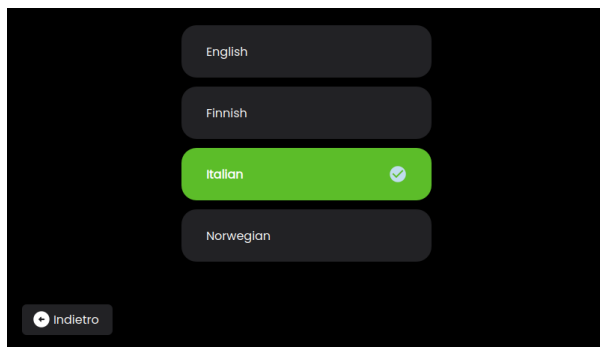

Image 11: Languages

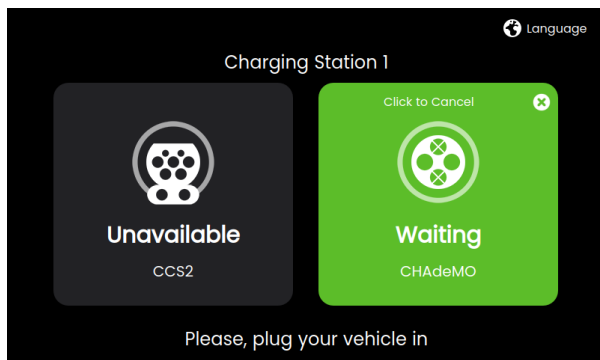

Image 12: Preparing CHAdeMO - connector unplugged

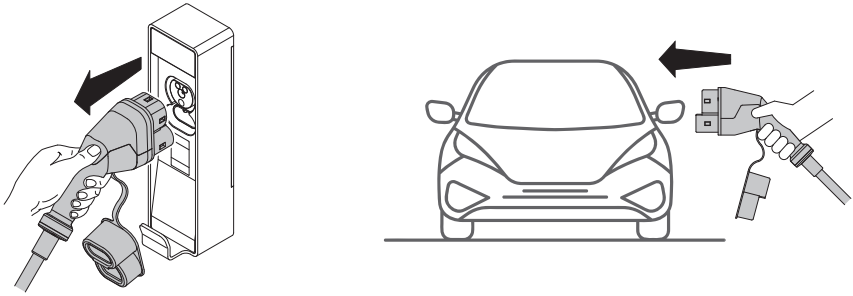

Image 13: charging operations



Image 14: Preparing CHAdeMO - connector plugged in

With most electric vehicles the charge process will proceed automatically from this point on. Instead, with older CHAdeMO EVs supporting only the first release of the protocol, i.e. CHAdeMO version 0.9.1, the plug presence into the EV inlet can not be automatically detected. Because of this, the end user must explicitly confirm that the CHAdeMO connector has in fact been inserted. This is done by tapping on the confirmation button shown by image 15.

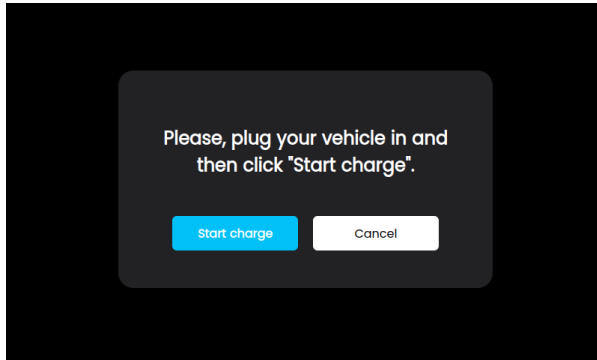

Image 15: confirm CHAdeMO

At this point the data link between the EV and the charger established and, after a few seconds of communication, the transfer of electric energy begins. Image 16 exemplifies the informative data being shown to the user, which include the status of the plug (reserved, charge in progress, charge completed), the State of Charge of the battery reported by the EV (SoC 0 to 100%), the amount of energy already delivered to the EV (kWh), the instantaneous power (kW), the time the charging started, and its duration (h:min).

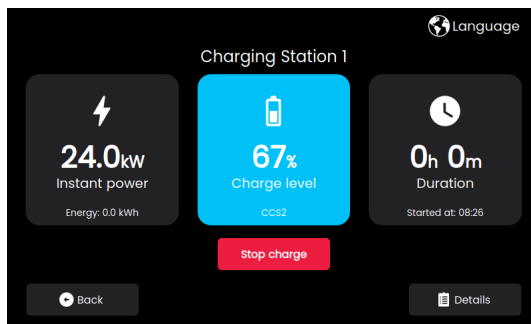

Image 16: process telemetry

The details of charging process will be displayed by tapping on bottom right corner of the screen.

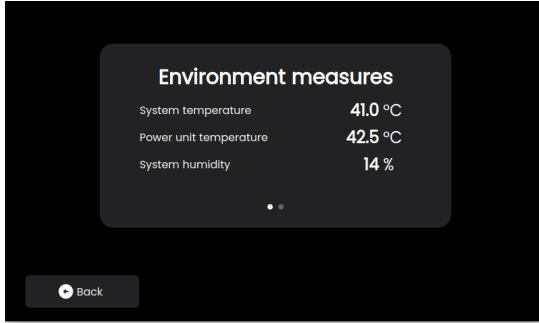

Image 17: detail 1

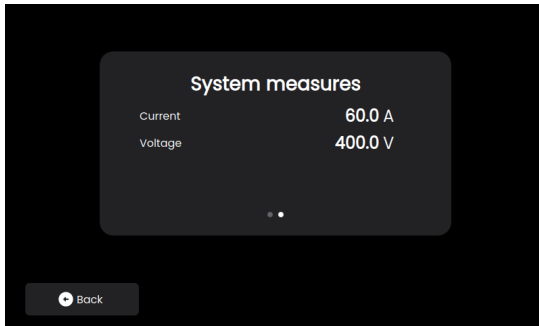

Image 18: detail 2

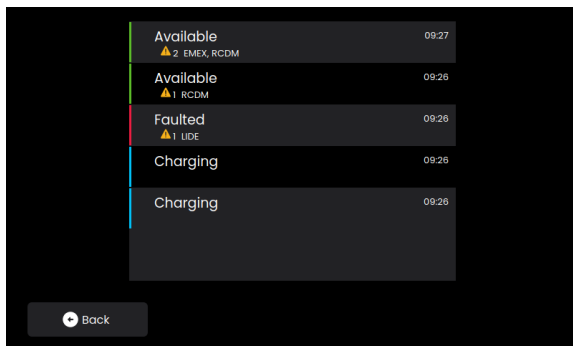

Image 19: error message

Should any error or fault occur during charging, a message similar to the one shown by image 19 will be posted.

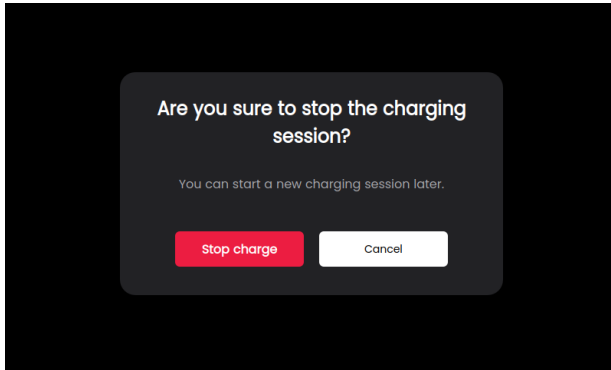

Image 20: confirm stop

The charging process will stop either automatically, when the EV reaches the preset SoC previously decided by the end user, or manually, if the end user so decides. In the second case a dedicated push button needs to be presses to confirm the decision. See image 20.

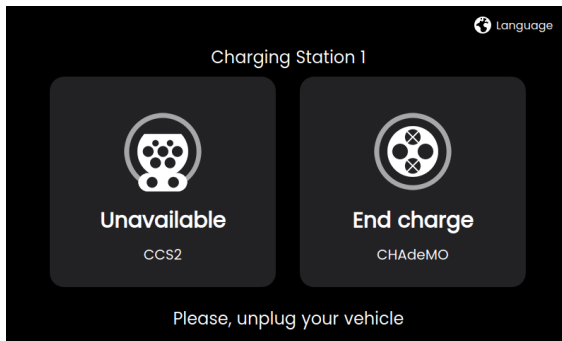

Image 21: stopping

If the unit operates in FREE mode, no identification is needed to stop the charge. The RFID card needs to be presented in front of the RFID reader otherwise.

BE-D SERIES

CONNECTIVITY

Every single model supports a standard wired Ethernet connection And comes with a built-in wireless router that provides mobile 4G(LTE)/3G/2G and WiFi connectivity as well. For mobile 4G(LTE)/3G/2G communication a SIM card needs to be inserted into the router. See image 22.

The SIM card will be activated upon agreement with customers.

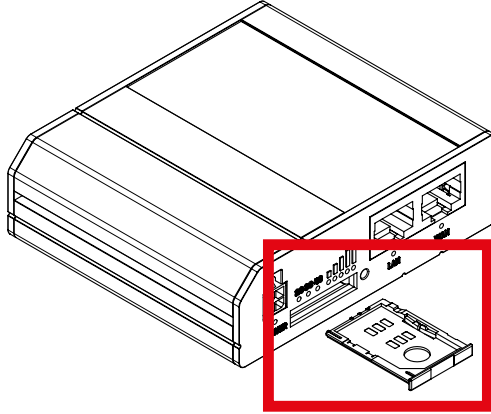

Image 22: wireless router with extended SIM card tray

PRODUCT SPECIFICATIONS, STANDARDS AND REGULATIONS

General Information

Description

SCAME DC WALLBOX, 25 kW, CE, 1 or 2 output connectors, CCS type 2 and CHAdeMO, 4.5 m cables, 7" TFT touch display, RFID reader, EMC Class A

Technical Data

Output Configurations	Configuration 1 (206.D91-E10): CCS type 2	Configuration 2 (206.D91-E11): CHAdeMO	Configuration 3 (206.D91-E12): CCS type 2+ CHAdeMO not simultaneously
Output power	Peak 25 kW Continuous 25 kW		
Number of EV Connectors	(CCS type 2) 1 piece	(CHAdeMO) 1 piece	(CCS type 2) 1Pc. (CHAdeMO) 1Pc.
Number of AC Socket Outlets	None		
Cable Length	4.5 m		
Min Output Voltage (Vout)	150 V DC		
Max Output Voltage (Vout)	(CCS type 2) 1000 V DC	(CHAdeMO) 500 V DC	(CCS type 2) 1000 V DC (CHAdeMO) 500 V DC
Maximum Output Current (Iout)	60 A DC		
AC Input power connection	3P + N + PE		
Supply Voltage	400 V AC +/- 10% (50 Hz or 60 Hz)		
AC Power Supply	Nominal 27 kW, 40 A / Peak 27 kW, 40 A		
Efficiency	94% at nominal power		
Mechanical dimensions	794 mm (H) x 594 mm (W) x 252mm (D)		
Weight	Approximately 70kg excluding the cables		
Ingress Protection rating	IP54		
Impact Resistance rating	IK10		
Ambient temperature	-30 to +50 °C (derating above +45°C, 14 kW at 50°C)		
Storage temperature	-30 to +60 °C		
Altitude	2500 m max		
Humidity	5% to 95% non condensating		
Acoustic noise	< 55dB in all directions		
Network Connections	GSM 3G/4G modem Ethernet port 1 x LAN 10/100Mbps WiFi IEEE 802.11b/g/n, Access Point (AP), Station (STA)		
Guaranteed Network Bandwidth	3G up to 42Mbps, 4G up to 150Mbps Ethernet 10Mbps		
Authentication Method	RFID ISO1443A MiFare Classic, MiFare Plus, MiFare DESFire		
HMI	7" TFT touch display with adjustable backlight Motion and ambient light sensors		
Communication	OCPP 1.6 JSON		

BE-D SERIES

CE conformity marking with the relevant EU directives:
2014/35/EU, Low Voltage Directive (LVD for Safety)
2014/30/EU, Electro-Magnetic Compatibility (EMC)
2014/53/EU, Radio Equipment Directive (RED) pending
2011/65/EU (RoHS2)

Standards and regulations

EMC Emission: Class A, IEC 61000-6-4, EMC Immunity: IEC 61000-6-2 industrial environments
IEC 61851-1
IEC 61851-21-2
IEC 61851-23
IEC 61851-24
IEC 61439-7
IEC 60529
REACH Regulation
UNI EN 17186

DIN SPEC 70121
CCS Basic

CHAdEMO ver. 0.9, ver. 1.1, ver. 1.2
edition 4.

DIN SPEC 70121
CCS Basic
CHAdEMO ver. 0.9, ver. 1.1, ver. 1.2
edition 4.

Power Meter AC

Class B MID (Energy meter 3P+N 63A Modbus MID)

Mounting method

Wall mounting

MAINTENANCE

The wall box is a full-fledged electrical cabinet. Maintenance should only be performed by qualified and authorized personnel.

Prior to opening the wall box front door, the power needs to be safely turned off at the main breaker in order to avoid danger of electrical shock or injury.

Do not remove or bypass any of the protective devices provided.

Every six months:

- the ventilation filters need to be replaced by authorized personnel (code 208.AP64).
- a visual inspection of the charging cables need to be performed. A cordset needs to be replaced should the corresponding cable show visual signs of fraying, deformation or any other type of damage.
- a visual inspection of the charging connectors need to be performed. A cordset needs to be replaced should the corresponding connector show structural damage to the mechanical body, exposed conductors, signs of rusting or arching of the conductive parts, or any other signs of damage

WARRANTY

THIS LIMITED WARRANTY IS EXPRESSLY LIMITED TO THE ORIGINAL PURCHASER ("PURCHASER") OF THE BE-D SCAME Charger ("CHARGING STATION").

DISPOSAL INSTRUCTIONS



"Implementation of Directive 2012/19/EU on Waste Electrical and Electronic Equipment (WEEE); pertaining to reduced use of hazardous substances in electrical and electronic equipment, as well as to waste disposal".

The symbol of the crossed-out wheelie bin on the equipment or on its packaging indicates that the product must be disposed of separately from other waste at the end of its service life.

The user must therefore take the dismissed equipment to suitable separate collection centres for electrical and electronic waste.

For more details, please contact the appropriate authority.

Suitable segregated collection of the equipment for subsequent recycling, treatment or environmentally-friendly disposal helps prevent damage to the environment and to human health, and encourages the re-use and/or recycling of the materials that make up the equipment.

Abusive disposal of the product by the user shall result in the application of administrative fines in accordance with the laws in force.



InfoTECH

ITALY	WORLDWIDE
<small>Numero Verde</small> 800-018009	ScameOnLine www.scame.com e-mobility@scame.com



VIA SPIAZZI, 45
24028 PONTE NOSSA (BG) ITALIA
TEL. +39 035 705000
FAX +39 035 703122
emobility-scame.com
e-mobility@scame.com